

THETFORD



Cooker Cocina 160-170 Series

User Manual
for use in GB



DECLARATION OF CONFORMITY

We: THETFORD Ltd

Address: Unit 6 Brookfields Way, Manvers, Rotherham, S63 5DL

Telephone: (+44) (0) 844 997 1960. Fax: (+44) (0) 844 997 1961

Declare under our sole responsibility that;

Product Types; Domestic build-in LP Gas and Natural Gas cooking appliances;

Model Number/Description; Cocina SCK16xxx & SCK17xxx Series LP Gas Cookers; Enigma SOH46xxx Series LP Gas Cookers and SOH46xxx Series Natural Gas Cookers;

Are in conformity with the relevant European Union harmonization legislation, Regulation (EU) 2016/426 which applies as from 21 April 2018 and are manufactured in accordance with the harmonised European standards; EN 30-1-1:2008+A3:2013 & EN 30-2-1:2015;

Satisfy the essential requirements of the Low Voltage Directive 2014/35/EU, where applicable and are manufactured in accordance with the harmonised European standards; EN 60335-1 (IEC 60335-1:2010); EN 60335-2-6 (IEC 60335-2-6:2002 +A1:2004 +A2:2008); EN 60335-2-102 (IEC 60335-2-102:2006 +A1:2010);

Satisfy the essential requirements of the Electro Magnetic Compatibility Directive 2014/30/EU and are manufactured in accordance with the harmonized European standards; EN 55014-1: 2006 + A1:2009 + A2:2011 & EN55014-2: 1997 + A1:2001 + A2: 2008; EN 61000-3-2:2006 +A1:2009 & EN 61000-3-3:2013 where applicable;

We also declare that the production of each specific model will be in conformity with the type as described in the EC type-examination certificate;

EC 680551, Issued by BSI

We also declare that the production of each specific model will be in conformity with the type as described in Test Report(s):

8783742, 8432405 & TR 14 404, Issued by BSI

Name : Bartho Anderson
Title/Position : Director
Place & Date of Issue : Rotherham 23rd February 2018

Signature

Index

EN

Original User Manual

Contents

1	Introduction.....	2
2	Symbols.....	2
3	Safety.....	3
4	Main components.....	7
5	Before use.....	7
6	Use of the burners.....	8
7	Use of the grill.....	9
8	Use of the oven.....	10
9	Safe cooking.....	10
10	Temperature control.....	11
11	Maintenance and cleaning.....	12
12	Gas leaks.....	13
13	Troubleshooting.....	13
14	Servicing.....	14
15	Putting in storage.....	14
16	Technical specifications.....	15
17	Disposal.....	15
18	Questions.....	16
19	Warranty.....	16

1. Introduction

This is the user manual for your Thetford cooker. Read the safety instructions and information on use and maintenance of the cooker carefully before continuing. This will enable you to use the cooker safely and efficiently. Retain this manual for future reference.

For the latest version of this manual, please visit www.thetford-europe.com.

2. Symbols

Key to symbols:



Warning. Risk of injury and/or damage.



Caution. Hot surface. Risk of injury and/or damage.



Attention. Important information.



Note. Information.

3. Safety

EN



This appliance may be used by children aged 8 years or older and persons with reduced physical, sensory or mental capabilities and/or lack of experience and knowledge only if they are supervised or have been given instructions on the safe use of this appliance and understand the potential hazards.



Keep children younger than 8 years away from the appliance, except under constant supervision.



Do not allow children to play with the appliance.



Do not allow children to clean or maintain this equipment unattended.



Use only parts supplied by the manufacturer.



Do not change or adjust anything on the appliance, unless the change is authorised by the manufacturer or its representative.



Use the appliance for cooking only and not for anything else, for example room heating. This can lead to carbon monoxide poisoning and overheating. The manufacturer cannot be held liable for damage

resulting from improper use or incorrect setting of the controls.



This appliance is not intended to be operated by means of an external timer or separate remote-control system.

The use of this gas cooking appliance results in the production of heat, moisture and products of combustion in the room in which it is installed.



Ensure the room has sufficient ventilation when the appliance is in use. During prolonged use, additional ventilation may be needed by opening a window or increasing the extraction force of the hood.



Never extinguish a cooking fire with water. Turn the burner off and cover the flame with a lid or a fire blanket.



The burners and pan supports are hot during and after use. Allow all parts to cool before touching them, as this can cause serious injury.



Unattended cooking on a hob with fat or oil can be dangerous and may result in fire. Do not leave the appliance unattended when in use.



The use of inappropriate hob guards can cause accidents.



Do not store items on the cooking surface of the hob.



The food shelves and trays in the appliance are hot during and after use. Allow all parts to cool before touching them, as this can cause serious injury.

Always use oven gloves when removing the shelves and trays.



Do not store items in the appliance.



Do not put heavy objects on the open appliance door.



The appliance and accessible parts become hot when the grill is in use. Young children should be kept away.



Caution, hot surfaces. Door must be open when grill is in use.



In the event that abnormal drift in cooking temperature of the oven is observed, have the thermostat checked by a qualified service engineer.



Care should be taken not to overload the oven, allowing adequate spacing to ensure free circulation of heat.



Do not use steam cleaners or pressure washers to clean the appliance. See Maintenance and cleaning for instructions.



Do not allow oil or fat to build up on the appliance. Clean the appliance after each use.



The glass lid may snap shut towards the end of lowering due to the travel-lock action of the hinges. Make sure all fingers are clear of the appliance when closing the lid.



Do not use harsh abrasive cleaners or sharp metal scrapers to clean the surface of the glass, since they can scratch the glass surface which may result in shattering of the glass.



Remove any spillage from the glass lid before opening the lid.



Do not shut the glass lid when the burners are lit or still warm.



4. Main components

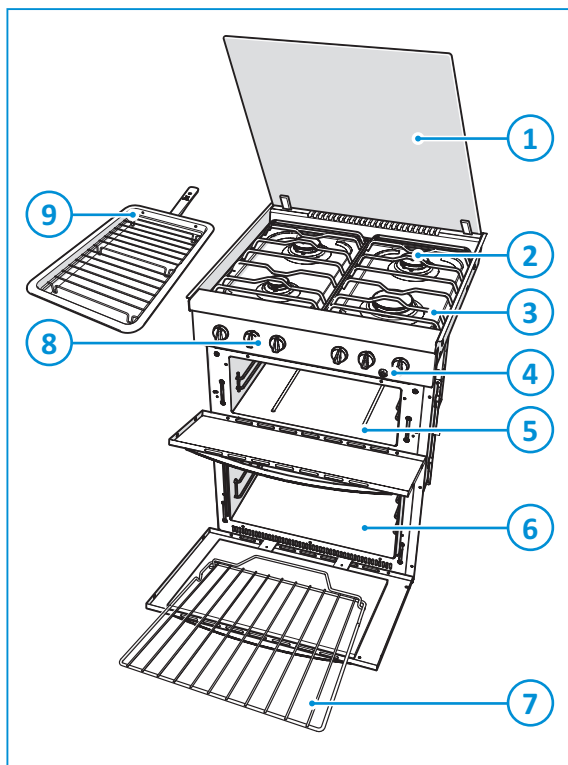

1. Glass lid (optional)
2. Gas burners
3. Pan supports
4. Spark ignition (optional)
5. Grill
6. Oven
7. Oven shelf
8. Control panel
9. Grill pan

EN

The types of burners may vary depending on the type of appliance. Refer to Technical specifications for further details.

5. Before use

Before using the appliance:

- Ensure that all packaging materials have been removed.
- Clean the appliance with warm water and household detergent and dry carefully with a soft cloth.
- Ensure that the gas supply is connected and turned on.
- Ensure that the appliance is connected to the electricity supply for the spark ignition and cooling fan.
- Ensure that the pan supports are positioned properly.
- Ignite the gas burners and let them burn to expel odours and vapours first.
- Ignite the burner and heat the grill for about 20 minutes to eliminate any residual factory lubricants that might impart unpleasant smells to the food being cooked. Smoke may occur

during this procedure. Open any windows and turn on mechanical ventilators to help remove the smoke.

- Ignite the burner and heat the oven for about 30 minutes at 200°C to eliminate any residual factory lubricants that might impart unpleasant smells to cooked food. Smoke may occur during this procedure. Open any windows and turn on mechanical ventilators to help remove the smoke.



Only use LPG (Liquefied Petroleum Gas). The appliance operates on propane or butane. Propane is preferred over butane, because butane provides poor performance at an ambient temperature below 10°C and cannot be used at an ambient temperature below 5°C.

6. Use of the burners

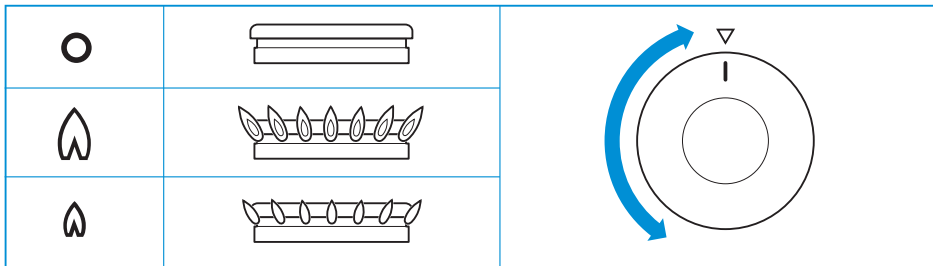

For the exact location of the control knobs, see Main components.

Turning on:

- Push and turn the control knob.
- Turn the control knob anti-clockwise to the full rate position.
 - For models fitted with spark ignition: Depress the ignition button.
 - For non-ignition models: Hold a lit match or gas match to the burners.
- Keep the control knob pressed for about 10-15 seconds and then release it.
- Adjust the height of the flame.



If the burner accidentally extinguishes turn the control knob to the 0 position and wait at least 1 minute before re-igniting the burner.



If the burner has not lit within 15 seconds turn the control knob back to the 0 position and release it. Wait at least 1 minute and repeat the steps above to turn on the appliance.

Turning off:

- Turn the control knob clockwise to the 0 position to turn off the burner.



Always make sure the control knob is in the 0 position when you have finished using the gas burners.



Do not shut the glass lid when the burners are lit or still warm.

7. Use of the grill

EN

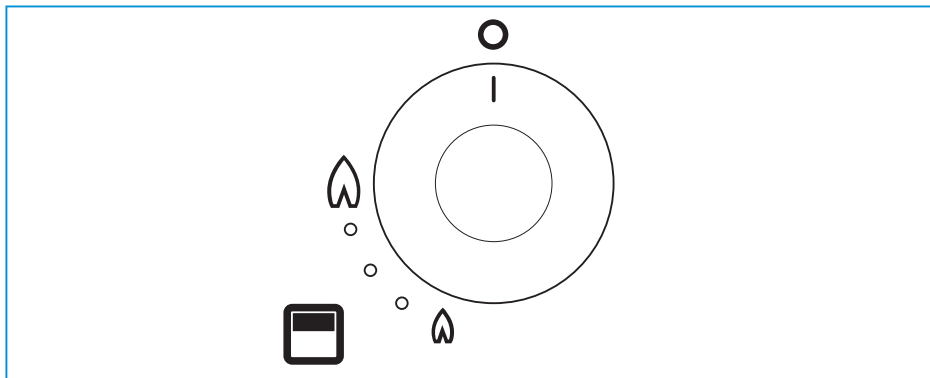

For the exact location of the control knob, see Main components.

Turning on:

- Open the door and push the control knob.
- Continue pressing the control knob and turn it anti-clockwise to the full rate position.
 - For models fitted with spark ignition: Depress the ignition button.
 - For non-ignition models: Hold a lit match or gas match to the burners.
- Keep the control knob pressed for about 10-15 seconds and then release it.
- Adjust the required heat setting.
- Depending on the food to be cooked, the correct grilling height can be achieved by inverting the pan trivet into either the high or low position.
- The grill pan supplied is multi-functional, for use in grill or oven and the handle design allows removal or insertion whilst the pan is in use. Always remove the handle when the pan is in use.
- Place the shelf in the required position.



The grill door must remain open when lighting and using the grill.



If the burner accidentally extinguishes turn the control knob to the 0 position and wait at least 1 minute before re-igniting the burner.



If the burner has not lit within 15 seconds turn the control knob back to the 0 position and release it. Wait at least 1 minute and repeat the steps above to turn on the appliance.



Although the grill heats up quickly, it is recommended that a few minutes preheat be allowed.



It is normal for the flames on this burner to develop yellow tips as the grill heats up.

Turning off:

- Turn the control knob clockwise to the 0 position to turn off the burner.



Always make sure the control knob is in the 0 position when you have finished using the grill.

8. Use of the oven

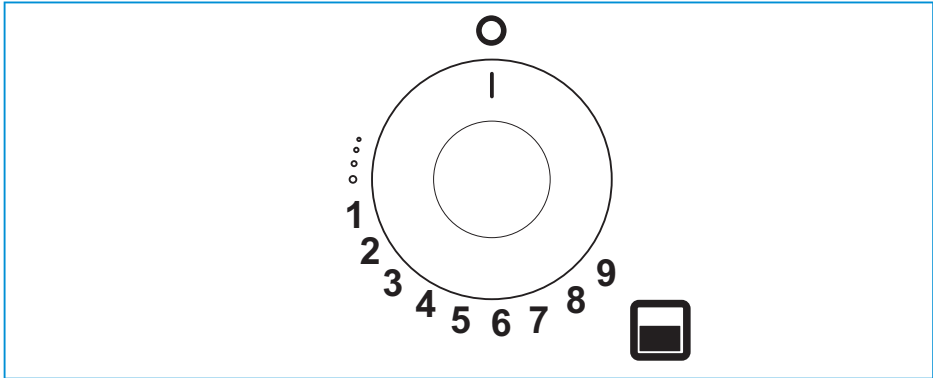

For the exact location of the control knob, see Main components.

Turning on:

- Open the door and push in the control knob.
- Continue pressing the knob and turn it anti-clockwise to the full rate position (240°C, gas mark 9).
 - For models fitted with spark ignition: Depress the ignition button.
 - For non-ignition models: Hold a lit match or gas match to the burners.
- Keep the control knob pressed for about 10-15 seconds and then release it.
- Adjust the required heat setting.
- Place the oven shelf in the required position and close the door.



Ignition must always be carried out with the oven door open.



If the burner accidentally extinguishes turn the control knob to the 0 position and wait at least 1 minute before re-igniting the burner.



If the burner has not lit within 15 seconds turn the control knob back to the 0 position and release it. Wait at least 1 minute and repeat the steps above to turn on the appliance.



Although the oven heats up quickly, a 10 minute preheat is recommended. The oven should reach full temperature in about 15-20 minutes.

Turning off:

- Turn the control knob clockwise to the 0 position to turn off the burner.



Always make sure the control knob is in the 0 position when you have finished using the oven.

9. Safe cooking

- Do not allow cooking vessels to overlap the edges of the appliance – use the correct sizes of pans and position them centrally over the burners.

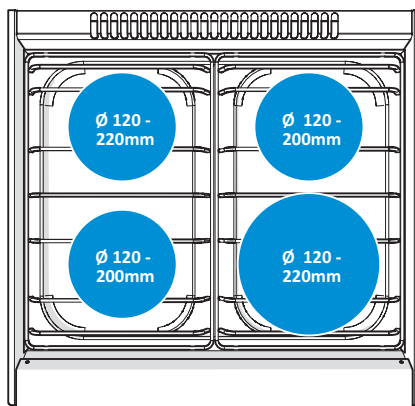

- Ensure that there is at least a 10mm gap between the pans and the edges of the hob.
- Turn the pans so that the handles do not overhang the front of the appliance.
- Ensure that the flame of the gas burner heats the bottom of the pan, not the sides.
- The pans and trays supplied with this appliance are the maximum sizes. Do not use larger pans and trays. They may restrict good circulation of heat, which may increase cooking times.
- The oven shelf allows good circulation at the rear of the oven.
- A raised bar at the rear of the shelf prevents trays or dishes making contact with the back of the oven.
- To remove a shelf, pull it forward until it stops, raise at the front and remove.
- To place a shelf in the oven, lower it at the front and slide it backward until it stops.
- The appliance is fitted with a cooling system. The cooling fan will automatically switch on a few minutes after the grill and/or oven is turned on, and will remain on even after the appliance has been switched off.
- The fan will automatically switch off a few minutes after the appliance has been switched off, when the appliance has cooled sufficiently.
- When either the grill or oven is first lit or after switching off, the cooling fan may operate intermittently. This is normal.
- Do not leave the appliance unattended when in use.
- Do not use the appliance while the vehicle is moving.
- Turn the control knob back to the 0 position after cooking.
- Keep the appliance clean and prevent accumulation of grease and food scraps.



Never cover slots or holes in the appliance and never cover a shelf with materials such as aluminium foil. That restricts the airflow and may cause carbon monoxide poisoning.





The food shelves and trays in the appliance are hot during and after use. Allow all parts to cool before touching them, as this can cause serious injury. Always use oven gloves when removing the shelves and trays.

10. Temperature control

The temperature in the oven is controlled by a thermostatic gas tap and is variable over the range 130°C to 240°C.

The table below provides a guide to the approximate temperatures at each of the shelf positions with respect to the gas mark setting. Good use can be made of the temperature variation between the shelf positions, as several dishes requiring different temperatures may be cooked at the same time. In this way maximum benefit can be obtained from the gas used to heat the oven.

Table 1: Temperature zones

Gas mark				Dish
1/4 - 1/2	90°C	110°C	130°C	Meringues
1	110°C	130°C	150°C	Stewed fruit
2	120°C	140°C	160°C	Rich fruit cake, rice pudding
3	130°C	150°C	170°C	Baked custard, shortbread fingers
4	140°C	160°C	185°C	Victoria sponge
5	155°C	180°C	200°C	Whisked sponges, ginger nuts
6	170°C	190°C	215°C	Short crust pastry
7	185°C	210°C	230°C	Bread, scones, flaky pastry
8	200°C	220°C	245°C	Puff pastry
9	215°C	240°C	260°C	Quick browning



Care should be taken not to overload the oven, allow adequate spacing to ensure free circulation of heat.



When roasting with aluminium foil ensure the foil does not impair circulation of heat or block any oven flue outlet.

11. Maintenance and cleaning

Thetford recommends an annual inspection service by an approved service centre. Between annual servicing, clean the appliance regularly after use. Before any cleaning work is started, the appliance should have been left to cool and be disconnected from the gas and electrical supplies.







- Always remove any spills or contamination immediately after use with soap and hot water. Towel dry the surface with a soft cloth.
- Use a non-abrasive multi-purpose cream cleaner and a nylon scourer pad to clean more stubborn dirt or grease.
- Use a proprietary stainless steel cleaner or polish to remove superficial surface scratching.



Do not use abrasive cleaners, metal scouring pads or hard brushes. They could damage the appliance.



If you clean the burner rings, ensure that the holes are not clogged.

-  Do not leave wet cloths, cleaning pads, residues of food or cleaning products or other dirt to dry on the surface. It can cause pitting, marking or even rusting.
-  Always clean in the direction of the brushed finish and not across the grain.
-  Cleaning agents containing bleach should not be left in contact with stainless steel.
-  Mineral content in water (such as iron or lime scale) can affect the appearance of the metal.
-  Remove any spillage from the glass lid before opening the lid.
-  The control knobs can be removed for cleaning. The knobs are easy to replace.

12. Gas leaks

As soon as you smell gas:

- Ensure that all burners are turned off.
- Extinguish all naked lights and do not smoke.
- Shut off the gas supply at the gas bottle immediately.
- Do not use electrical switches.
- Open all doors and windows.

 LPG is heavier than air. Escaping gas accumulates at lower levels. By following the strong, unpleasant smell of gas, you can determine where the leak is located. To investigate where it is exactly, use a special leak detection spray. Never use an open flame to find the leak!

13. Troubleshooting

Problem	Possible cause	Solution
Burners do not burn or burn unevenly	Gas bottle is empty Gas tap is closed Burner caps are not correctly positioned Burners are wet or clogged	Change gas bottle Open tap Allow caps to cool, then re-position them Dry or clean burners
Spark ignition does not spark	12V DC battery is discharged Connections are loose Ignition points are wet or dirty	Charge battery Secure connections Dry or clean ignition points
Control knobs do not function	Knobs are mounted incorrectly	Install knobs correctly

 If you cannot solve a problem, contact the authorised local Service Centre or Thetford Customer Service in your country.

14. Servicing

All servicing must be carried out by an approved competent person. Before any service work is started, the appliance should have been left to cool and be disconnected from both the gas and electrical supplies. After each service the appliance must be checked for gas soundness and electrical safety.

For service, please contact your authorised local Service Centre giving details of the model and serial number on the data badge plus date of purchase.



Model Name & Series Number				
G30 G31	CAT I ₂ +(28-30/37) BUTANE 28-30mbar PROPANE 37mbar	CAT I ₃ B/P(30) BUTANE 30mbar PROPANE 30mbar	THETFORD	
ΣQn	Power kW (g/hr)	Model Number	Spark Ignition	
CE	Pin Number	Serial Number	Voltage ~ 50 Hz	
Country Codes 1		Country Codes 2	Power kW	
			QC Pass	Order No

15. Putting in storage



- Close the gas valve at the gas bottle.
- Automatic ignition models only: Disconnect the electricity supply.
- Ensure that the control knobs are in the 0 position.
- Close the glass lid.
- Close the grill door.
- Close the oven door.
- Wipe the appliance clean and dry.

16. Technical specifications

Table 2: Burner specifications

	SCK160 series		
	Somipress burners & Copreci taps		
	Gas input		Injector
			
	kW	g/hr	mm
Gas burners	1 x 2.4 2 x 1.5 1 x 1.0	1 x 173 2 x 108 1 x 72	0.77 0.61 0.52
Oven burner	1.8	130	0.66
Grill burner	2.5	180	0.78
Total	10.7	771	

EN

	SCK170 series		
	Somipress burners & Copreci taps		
	Gas input		Injector
			
	kW	g/hr	mm
Gas burners	1 x 2.4 2 x 1.5 1 x 1.0	1 x 173 2 x 108 1 x 72	0.77 0.61 0.52
Oven burner	2.6	187	0.78
Grill burner	2.5	180	0.78
Total	11.5	828	



This appliance is suitable for use with LPG (Liquefied Petroleum Gas) and should not be used with any other gas.



This appliance must be earthed.

17. Disposal

Your product has been designed and manufactured with high quality materials and components, which can be recycled and reused. When your product has reached its end of life, dispose of the

product according to the local rules. Do not dispose of the product with the normal household waste. The correct disposal of your old product will help prevent potential negative consequences to the environment and human health.

18. Questions

If you have questions about your product, parts, accessories or authorised services:

- Visit www.thetford-europe.com.
- If you cannot solve a problem, contact the authorised local Service Centre or Thetford Customer Service in your country.

19. Warranty

Thetford BV offers the end users of its products a three-year warranty. In the case of malfunction within the warranty period, Thetford will replace or repair the product. In this situation, the costs of replacement, labour costs for the replacement of defective components and/or the costs of the parts themselves will be paid for by Thetford.

Purchased spare parts carry a one-year warranty. Any fitting and/or labour costs are not covered by warranty.

1. To submit a claim under this warranty, the user must take the product to an authorised Thetford Service Partner. The claim will be assessed there.
2. Components replaced during repair under warranty become the property of Thetford.
3. This warranty does not prejudice current consumer protection laws.
4. This warranty is not valid in the case of products that are used for commercial purposes.
5. Warranty claims falling into one of the following categories will not be honoured:
 - The product has been improperly used or the instructions in the manual have not been followed;
 - The product has not been installed in accordance with the instructions;
 - Modifications have been made to the product;
 - The product has been repaired but not by an authorised Thetford Service Partner;
 - The serial number or product code has been tampered with or removed;
 - The product has been damaged by misuse.

EUROPEAN HEADQUARTERS

Thetford B.V.
Nijverheidsweg 29
P.O. Box 169
4870 AD Etten-Leur
The Netherlands

T +31 76 504 22 00
F +31 76 504 23 00
E info@thetford.eu

FRANCE

Thetford S.A.R.L.
Parc BUROPLUS / Bâtiment 6
18, Boulevard de la Paix
95800 CERGY
France

T +33 1 30 37 58 23
F +33 1 30 37 97 67
E infof@thetford.eu

SCANDINAVIA

Thetford B.V.
Representative Office Scandinavia
Hantverkaregatan 32D
521 61 Stenstorp
Sverige

T +46 31 336 35 80
F +46 31 44 85 70
E infos@thetford.eu

UNITED KINGDOM

Thetford Ltd.
Unit 6
Brookfields Way
Manvers, Rotherham
S63 5DL, England
United Kingdom

T +44 844 997 1960
F +44 844 997 1961
E infof@thetford.eu

ITALY

Thetford Italy c/o Tecma s.r.l.
Via Flaminia
Loc. Castel delle Formiche
05030 Otricoli (TR)
Italia

T +39 0744 709071
F +39 0744 719833
E infoi@thetford.eu

AUSTRALIA

Thetford Australia Pty. Ltd.
41 Lara Way
Campbellfield VIC 3061
Australia

T +61 3 9358 0700
F +61 3 9357 7060
E infoau@thetford.eu
www.thetford.com.au

GERMANY

Thetford GmbH
Schallbruch 14
D-42781 Haan
Deutschland

T +49 2129 94250
F +49 2129 942525
E infod@thetford.eu

SPAIN AND PORTUGAL

Mercè Grau Solà
Agente para España y Portugal
c/ Castellet, 36 bxs 2ª
08800 Vilanova i la Geltrú
Barcelona
España

T +34 938 154 389
F not available
E infof@thetford.eu

CHINA

Thetford China
Rm. 1207, Coastal Building
(East Block)
Haide 3rd Road, Nanshan District
Shenzen, 518054
China

T +86 755 8627 1393
F +86 755 8627 1673
E info@thetford.cn
www.thetford.cn